



Read



Scan

<https://manuals.avionaut.com/product/292-1>

Stardust RWF

61-105cm / max. 21kg



Warning:

Do not modify the Stardust child safety seat in any way, as it may affect the child's safety during its use.



Warning:

Never place the Stardust child safety seat on an elevated surface, e.g. on a table or chair.



Warning:

Do not use in rearward facing configuration in seating positions where there is an active frontal airbag installed.



Warning:

The Stardust child safety seat should only be installed in the car facing backwards to the driving direction.



Warning:

Rigid items and plastic parts of an Enhanced Child Restraint System shall be located and installed so that they are not liable to become trapped by a movable seat or in a door of the vehicle during everyday use of the vehicle.



Warning:

Any alterations or additions to the device without the approval of the Type Approval Authority, and a danger of not following closely the installation instructions provided by the child restraint manufacturer.



Warning:

For more information, please refer to the vehicle manufacturer's handbook.



Warning:

It is totally forbidden any alterations or additions to the device without the approval of the Type Approval Authority,



Warning:

Follow closely the installation instructions provided by the child restraint manufacturer



Warning:

The Enhanced Child Restraint System cover should not be replaced with any other than the one recommended by the manufacturer, because the cover constitutes an integral part of the restraint performance



Warning:

Ensuring that any lap strap is worn low down so that the pelvis is firmly engaged



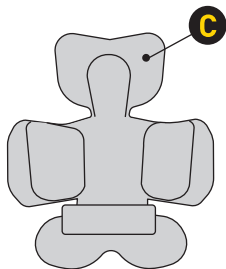

Additional accessories

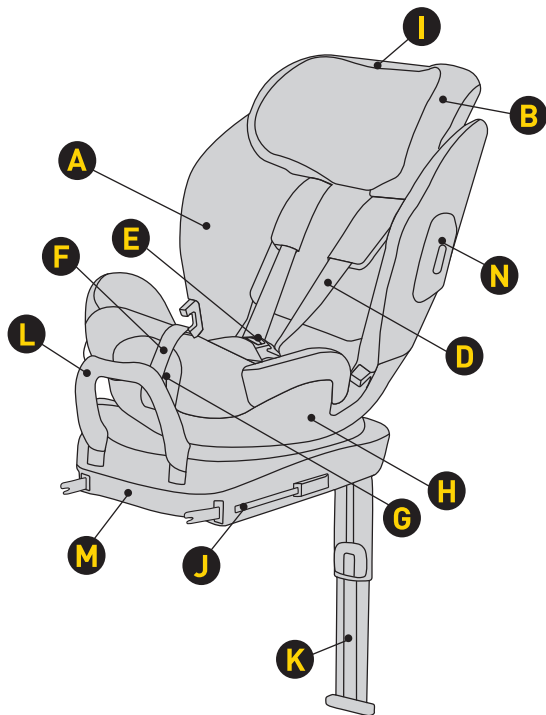

Installation using Isofix system

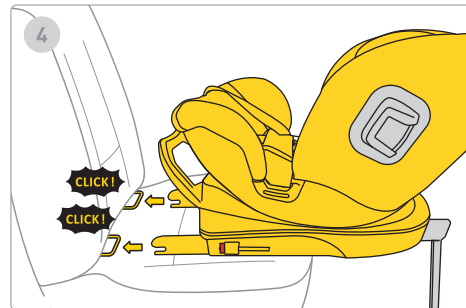
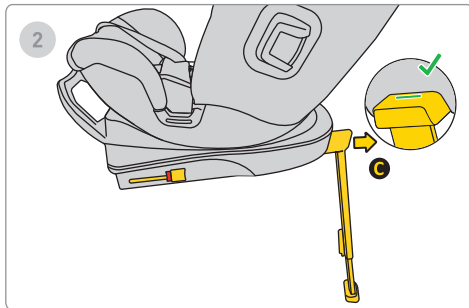
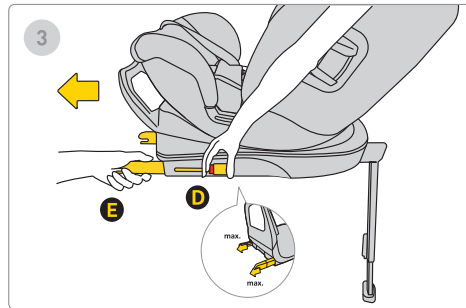
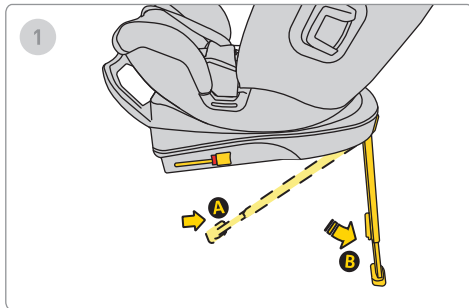

Installation using Isofix system

5

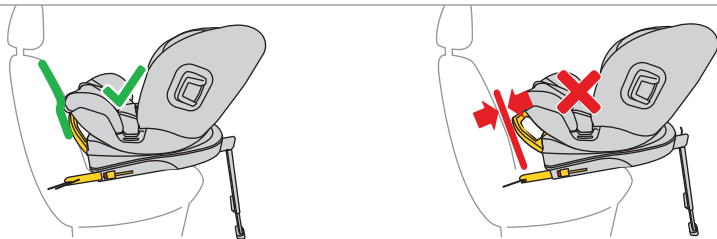
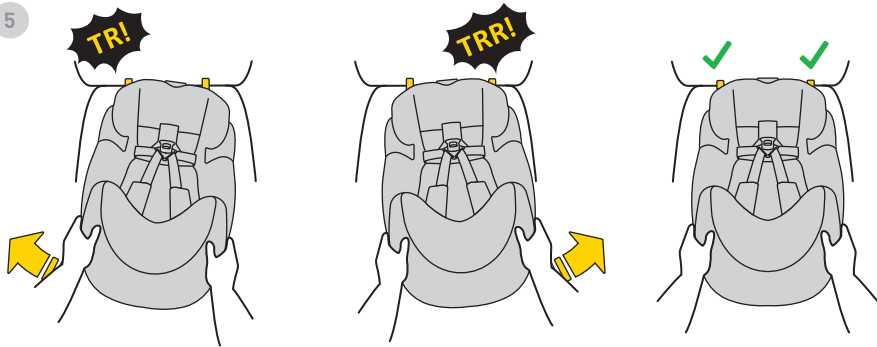

Installation using Isofix system

6

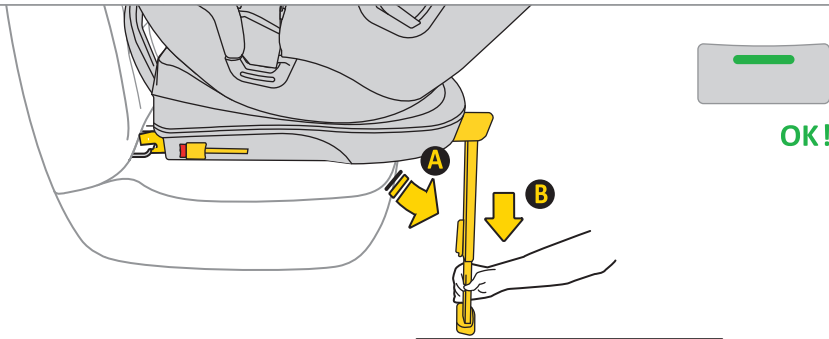

Bumper

1

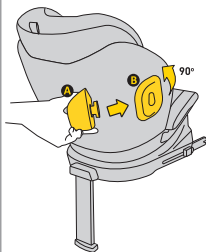

2

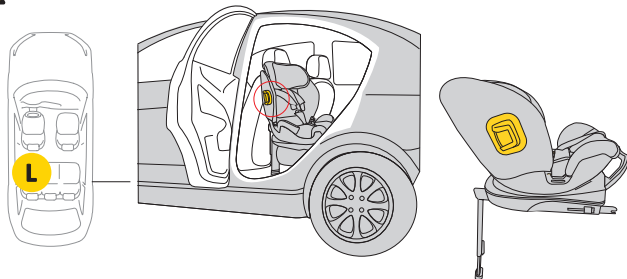
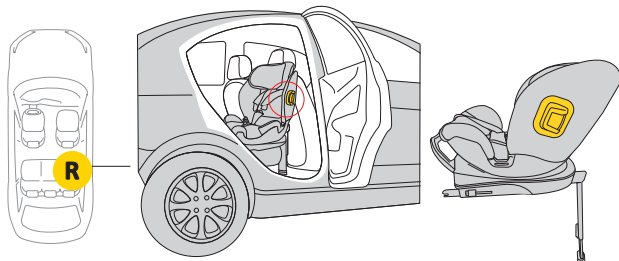

Rotation

1

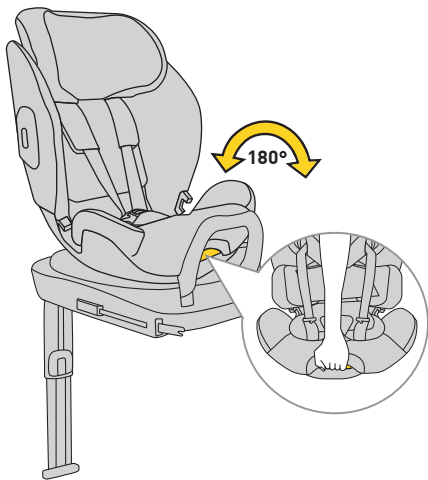

Installation using Isofix system 61-105 cm

1



61-105 cm
max. 21 kg

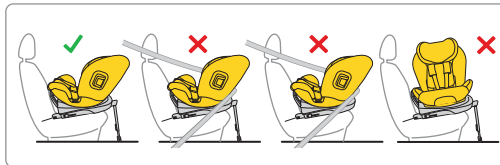
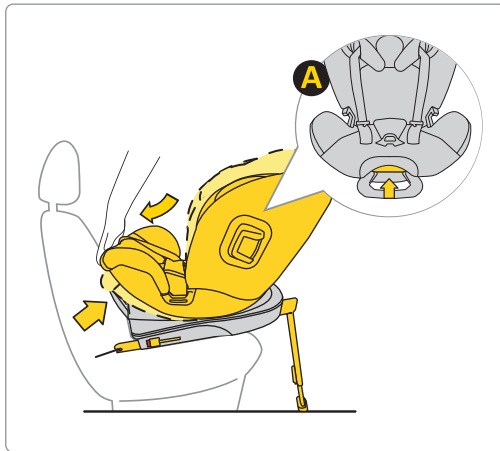

Installation using Isofix system 40-105 cm

1



40-105 cm
max. 21 kg



Warning urgent:

Seat applicable in range from 40cm
only with approved insert - sold separately

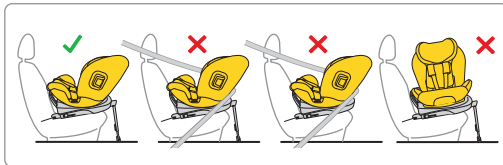

Insert (sold separately)

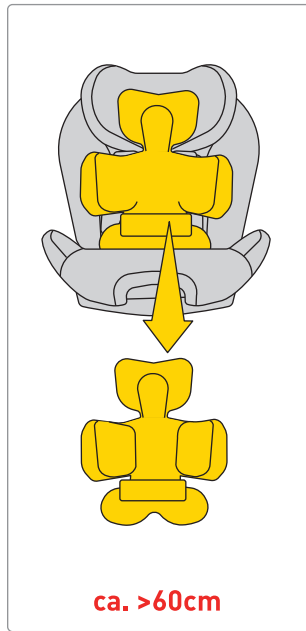
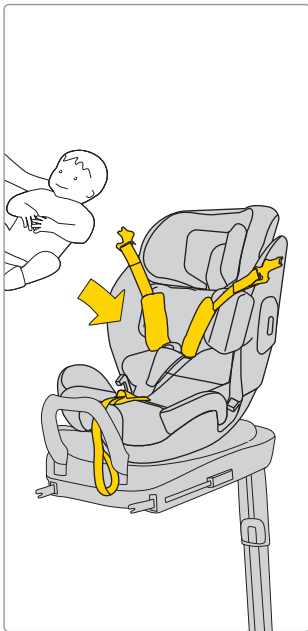

Child safety

1

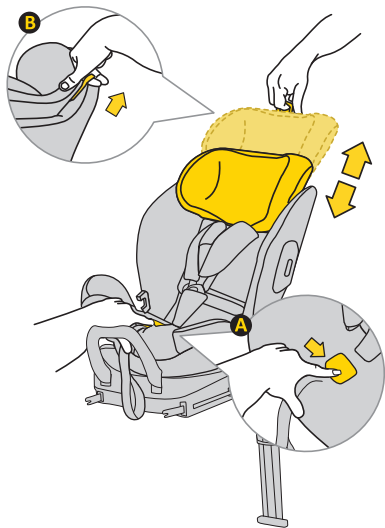

2

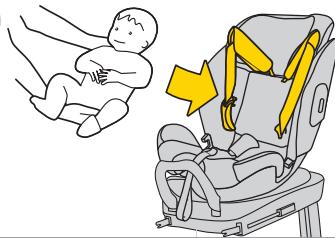

Child safety

3

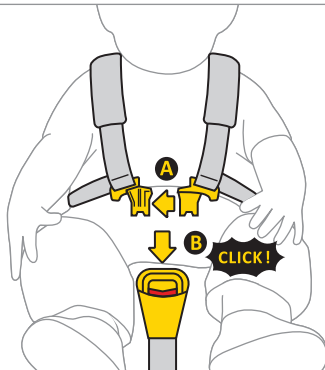

4

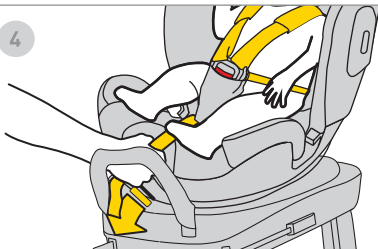

5



Uninstallation of Isofix system

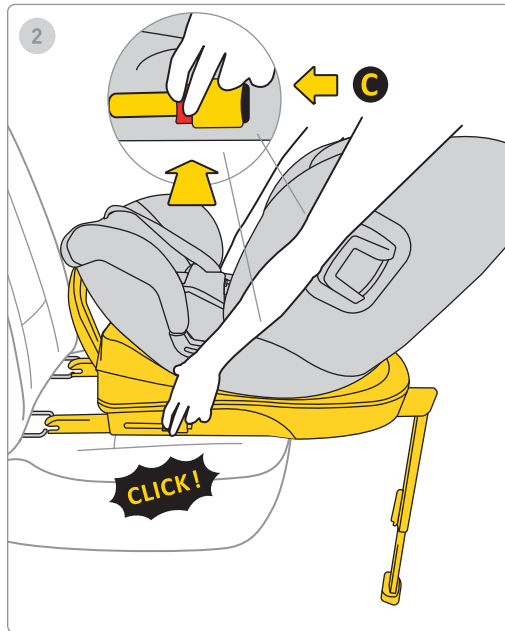
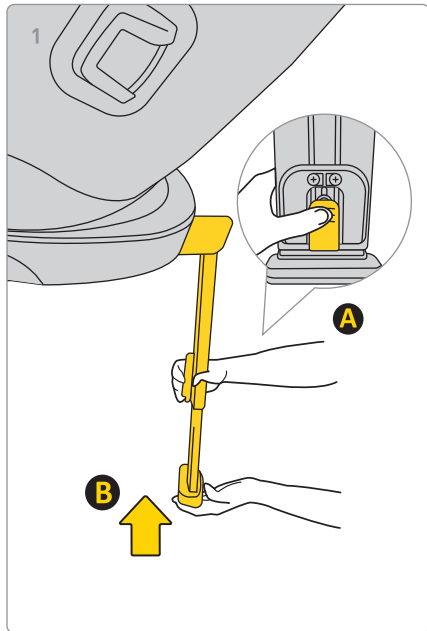

Uninstallation of Isofix system

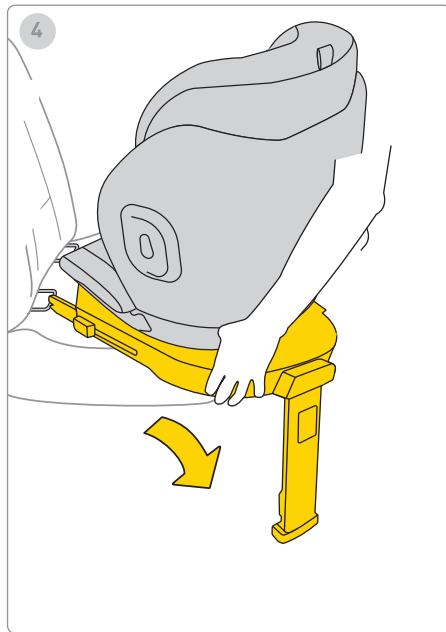
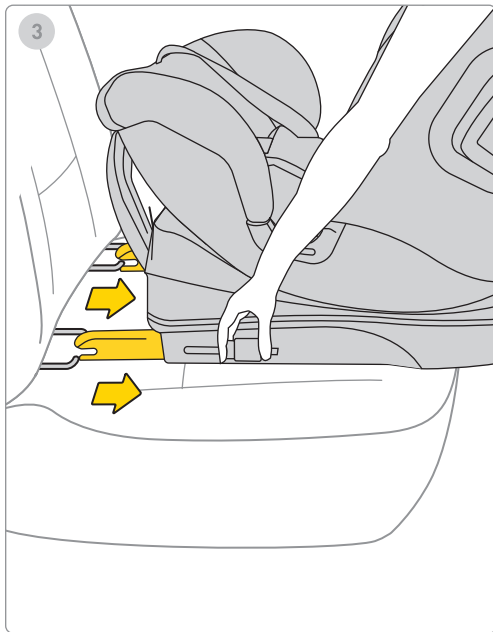

Warning

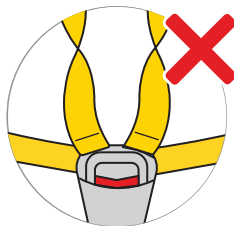
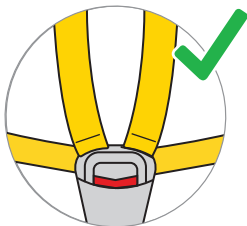

Cleaning

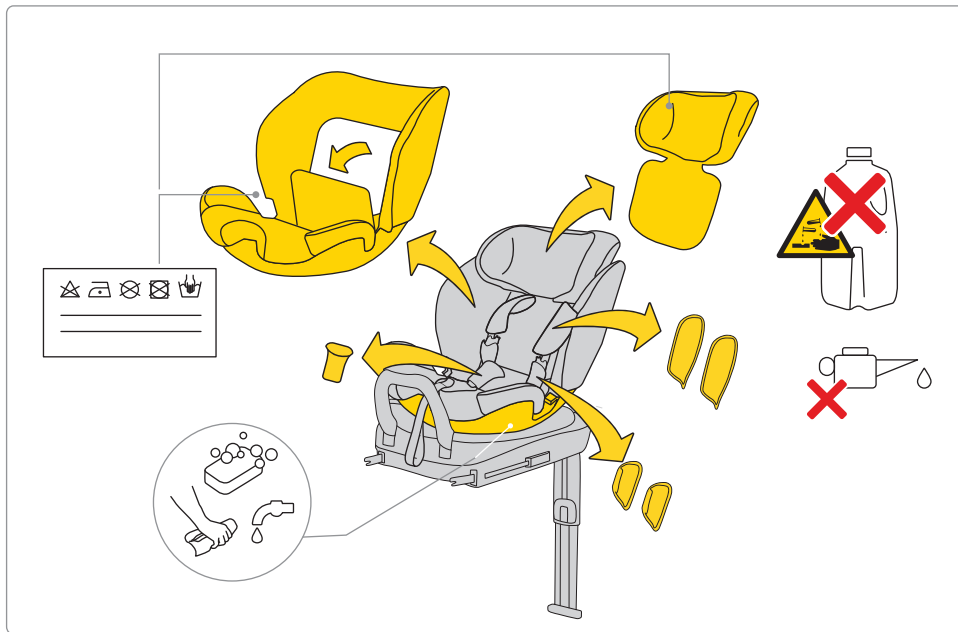

Cleaning

1

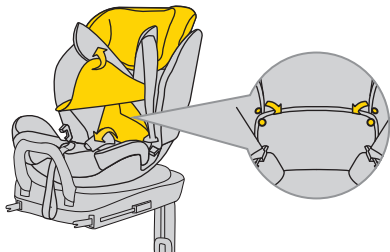

2

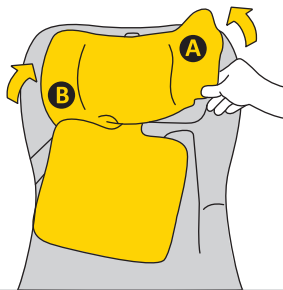

3

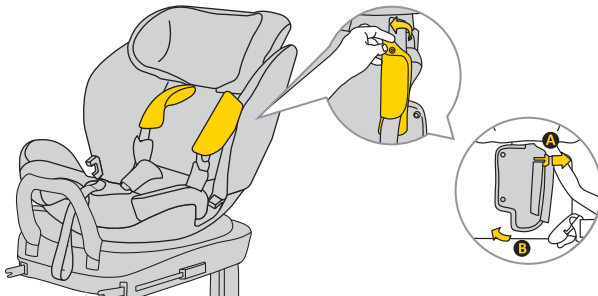

Cleaning

4



5

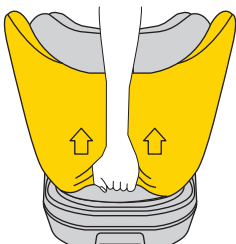

6

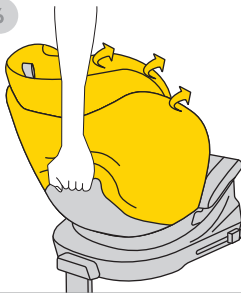

7

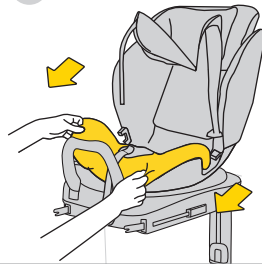

ADRESS:

Ł.KARWALA
Szarlejka, ul. Łukaszewicza 172
42-130 Wręczyca Wielka
POLAND

Telefon: +48 34 317 66 10

Fax: +48 34 317 66 95

E-mail: avionaut@avionaut.com

www.avionaut.com